

# ELECTRONIC TAGS

## VORMATIC ESL TAG 1.5 SPECIFICATION

Datasheet: V1.3

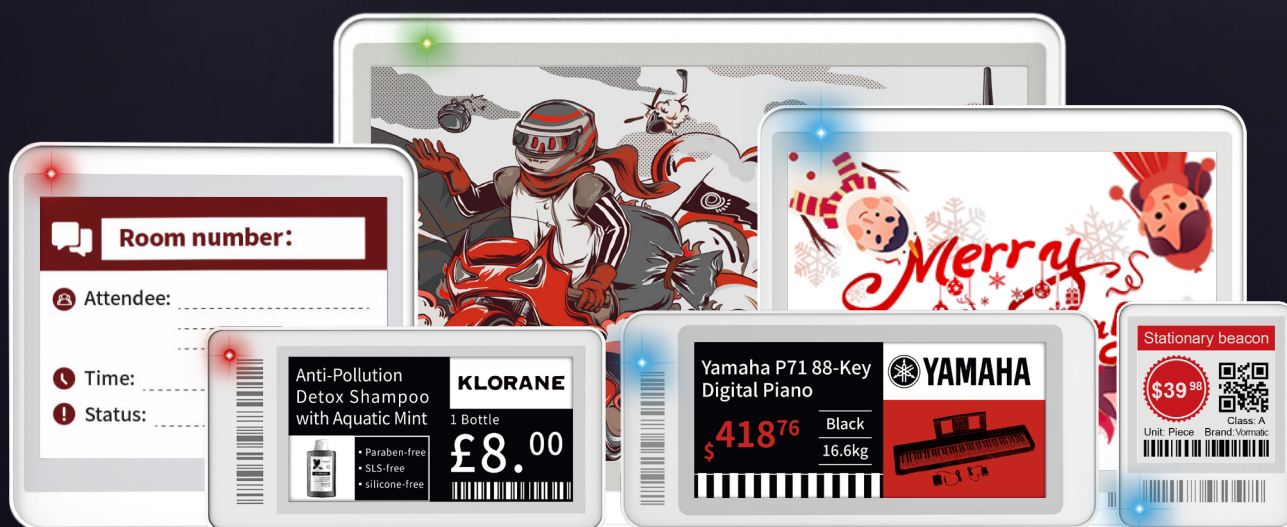

# ESL TAG 1.5

## BRIEF INTRODUCTION







Vormatic Mercurius Series, independently designed by Vormatic, are utilising the latest Bluetooth® Low Energy5.0 Technology. ESL TAG 1.5 features the latest e-ink display technology, providing fully graphic display, agile &flexible information updates. Also it delivers a near 180° viewing angle for excellent readability.



## SPECIFICATION

Material	ABS+PC
Color	White
Dimension	36 * 46 * 14 mm
Display Technology	EPD
Screen size	1.54 inch
Display Area	27*27mm
Resolution	152 * 152px
Pixel Density	142 dpi
Weight	21 g
Battery Lifetime	5 Years(1 update/day)
Fixing Ways	Shelf Rail etc.
Display Color	ESL TAG 1.5 R-Black/White/Red ESL TAG 1.5 Y-Black/White/Yellow ESL TAG 1.5 B-Black/White

## HIGHLIGHT

-  Updating in seconds
-  5-year battery lifetime (1 update/day)
-  REST API
-  RGB LED location
-  Managed by Cloud/APP
-  NFC Optional

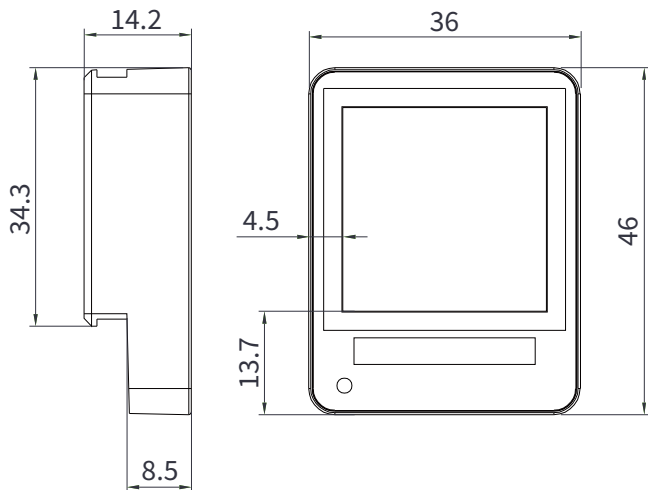

## TECHNICAL PARAMETER

Communication Protocol	Bluetooth®Low Energy 5.0
Battery	CR2450 * 1
Transmitting Distance	30-60 Meters
Working Humidity	50±20%RH
Operating Temperature	0°C-50°C
Storage Temperature	-20°C-60°C
Protection Level	IPX5

## COMPLIANCE

Certification	BQB/FCC/CE/RoHS
---------------	-----------------



## FCC Requirement

changes or modifications not expressly approved by the party responsible for compliance could void the user's authority to operate the equipment.

This device complies with Part 15 of the FCC Rules. Operation is subject to the following two conditions:

- (1) this device may not cause harmful interference, and
- (2) this device must accept any interference received, including interference that may cause undesired operation.

Note: This equipment has been tested and found to comply with the limits for a Class B digital device, pursuant to Part 15 of the FCC Rules. These limits are designed to provide reasonable protection against harmful interference in a residential installation. This equipment generates, uses, and can radiate radio frequency energy, and if not installed and used in accordance with the instructions, may cause harmful interference to radio communications. However, there is no guarantee that interference will not occur in a particular installation. If this equipment does cause harmful interference to radio or television reception, which can be determined by turning the equipment off and on, the user is encouraged to try to correct the interference by one or more of the following measures:

- Reorient or relocate the receiving antenna.
- Increase the separation between the equipment and receiver.
- Connect the equipment into an outlet on a circuit different from that to which the receiver is connected.
- Consult the dealer or an experienced radio/TV technician for help.

